



**Schutz vor Korrosion**

**Anti-corrosion protection | Protection contre la corrosion | Protezione anticorrosiva**

Doppelt gebrannte Zweischicht-Emallierung nach DIN 4753. Grosszügige Magnesium Schutzanode nach DIN 4753-3. Speicher mit separater Isolierung sind aussen mit einem Antikorrosionslack lackiert.

**EN** Dual-fired two-layer enamelling in accordance with DIN 4753. Generous magnesium protection anode in accordance with DIN 4753-3. Storage tanks with separate insulation are coated on the exterior with an anticorrosion paint.

**FR** Émaillage bi-couche à double cuisson conforme à la norme DIN 4753. Anode de protection de belle taille en magnésium conforme à la norme DIN 4753-3. Les réservoirs avec isolation séparée sont recouverts à l'extérieur d'une laque anticorrosion.

**IT** Smaltatura a doppia mano secondo DIN 4753. Anodo protettivo di magnesio in grande quantità secondo DIN 4753-3. Gli accumulatori con isolamento separato sono verniciati esternamente con smalto resistente alla corrosione.

**Wärmetauscher**

**Heat exchanger | Échangeur de chaleur | Scambiatore di calore**

Zwei eingeschweisste grossflächige Wärmetauscher.

**EN** Two welded large-surface heat exchangers.

**FR** Deux échangeurs de chaleur grande surface soudés.

**IT** Due scambiatori di calore di grande superficie saldati.

**Isolierung**

**Insulation | Isolation | Isolamento**

**PU-Hartschaum**

60 mm PU-Hartschaum fix geschäumt. Skaimantel 5 mm mit Reissverschluss vormontiert, inklusive Rosetten und Abdeckhaube. Brandschutzklasse B2. Silber. Weitere Farben nach Absprache.

**UltraShell**

Mehrschicht-Isolierung aus 80 mm Hartschaum + 20 mm Faservlies. PS-Mantel und Hakenleiste, inklusive Rosetten und Abdeckhaube. Brandschutzklasse B2. Silber. Lose geliefert.

**EN Rigid polyurethane foam**

60 mm rigid polyurethane foam. Skai jacket 5 mm with zip preassembled, including cover plates and hood. Fire-resistance rating B2. Silver. Other colours on request.

**FR Mousse solidifiée PU**

60 mm de mousse dure PU Enveloppe en skai de 5 mm préinstallée avec fermeture à glissière, y compris rosettes et capot. Classe allemande de protection incendie B2. Argent. Autres couleurs après concertation.

**IT Schiuma PU rigida**

60 mm di schiuma rigida di poliuretano fissa. Mantello in skai da 5 mm pre-assemblato con cerniera, dotato di rosette e calotta di copertura. Classe di resistenza antincendio B2. Argento. Altri colori su richiesta.

**UltraShell**

Multilayer insulation made of 80 mm rigid foam + 20 mm fibre fleece. PS jacket and hook rack, including cover plates and hood. Fire-resistance rating B2. Silver. Supplied loose.

**UltraShell**

Isolation multicouches constituée de 80 mm de mousse dure + 20 mm de tissu fibreux. Enveloppe en PS équipée d'un support à crochets préinstallé, y compris rosettes et capot. Classe allemande de protection incendie B2. Argent. Livrée non montée.

**UltraShell**

Isolamento multistrato con 80 mm di schiuma rigida + 20 mm di tessuto non tessuto. Mantello in PS e barra con ganci, rosette e calotta di copertura incluse. Classe di resistenza antincendio B2. Argento. Consegna sfusa.

≤ 600 L  
PU-Hartschaum  
B2; λ = 0.026 W/(mK)

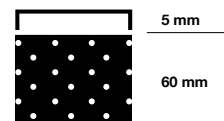

800 – 2000 L  
UltraShell  
B2; λ = 0.0316 W/(mK)

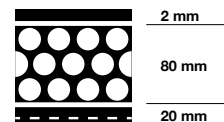

**Wassererwärmer für Wärmepumpenanlagen**  
**Domestic hot water tank**  
**Ballon eau chaude sanitaire**  
**Serbatoio di accumulo acqua calda sanitaria**  
**DSFF/E 200–2000**



**Emailliert**  
 Enamelled | Émaillés | Smaltato

Typ DSFF/E		200	300	400	500	600	800	1000	1250	1500	1750	2000
Inhalt Capacity   Contenance   Contenuto	l	191	304	408	498	562	830	925	1226	1413	1728	1926
Ø mit Isolierung with insulation   avec isolation   con isolamento	mm	600	650	750	750	750	990	990	1100	1200	1300	1300
Ø ohne Isolierung without insulation   sans isolation   senza isolamento	mm	-	-	-	-	-	790	790	900	1000	1100	1100
Höhe mit Isolierung Height with insulation   Hauteur avec isolation   Altezza con isolamento	mm	1215	1570	1500	1800	2000	1990	2190	2240	2120	2150	2350
Kippmass Tilted dimension   Cote de basculement   Altezza in raddrizzamento	mm	1355	1700	1680	1950	2140	1990	2190	2260	2120	2200	2355
Betriebsdruck Heizung Heater operating pressure   Pression de service du chauffage   Pressione d'esercizio riscaldamento	bar	6	6	6	6	6	6	6	6	6	6	6
Betriebsdruck Wasser Water operating pressure   Pression de service de l'eau   Pressione d'esercizio acqua	bar	6	6	6	6	6	6	6	6	6	6	6
Prüfdruck Test pressure   Pression test   Pressione di collaudo	bar	12	12	12	12	12	12	12	12	12	12	12
max. Betriebstemperatur max. operating temperature   Temp. de service max.   Temperatura max. d'esercizio	°C	95	95	95	95	95	95	95	95	95	95	95
Gewicht Weight   Poids   Peso	kg	98	134	152	185	205	279	318	368	410	434	483
Art.Nr. Part no.   Réf.   Art.n.	100103...	0200	0300	0400	0500	0600	0800	1000	1250	1500	1750	2000
<b>Isolierung</b> Insulation   Isolation   Isolamento		<b>60 mm</b> fix eingeschäumt Fixed with foam   Enrobage mousse fixe   Schiuma rigida fissa					<b>UltraShell 100</b>					
Wärmeverlust Heat losses   Pertes thermiques   Perdita di calore	kWh/24h	0.98	1.40	1.64	1.89	2.03	3.26	3.44	3.6	3.77	4.01	4.38
ErP-Klasse ErP class   Classe ErP   Classe ErP		A	B	B	B	B	C	C	C	C	C	C
Gewicht Weight   Poids   Peso	kg	-	-	-	-	-	35	40	45	50	55	60
Art.Nr. Part no.   Réf.   Art.n.	300103...	-	-	-	-	-	0809	1009	1259	1509	1759	2009

Typ DSFF/E		200	300	400	500	600	800	1000	1250	1500	1750	2000
<b>Glattrohrwärmetauscher unten</b> Bottom heating coil   Échangeurs de chaleur bas   Serpentino inferiore	m <sup>2</sup>	1.0	1.6	1.9	2.4	2.4	3.7	3.7	4.1	4.4	5.0	5.4
<b>Inhalt Glattrohrwärmetauscher</b> Heating coil capacity   Contenance échangeurs de chaleur   Contenuto serpentino	l	5.8	9.9	12.4	15.5	15.5	24.2	24.2	27.0	28.8	32.9	35.3
<b>Durchflussmenge</b> Throughput   Débit   Portata flusso	m <sup>3</sup> / h	1.3	2.0	2.4	3.0	3.0	4.7	4.7	5.2	5.6	6.3	6.8
<b>Druckverlust</b> Pressure loss   Perte de charge   Perdita di pressione	mbar	20	70	110	230	230	160	160	220	280	400	510
<b>Dauerleistung</b> Continuous output   Régime permanent   Potenza continua 10°C / 45°C / 80°C	l / h	362	580	688	870	870	1339	1339	1486	1594	1812	1957
<b>max. Glattrohrwärmetauscherleistung</b> max. heating coil output   Puissance max. du échangeurs de chaleur   Potenza max. serpentino	kW	14.7	23.6	28.0	35.3	35.3	54.5	54.4	60.4	64.8	73.6	79.5
Typ DSFF/E		200	300	400	500	600	800	1000	1250	1500	1750	2000
<b>Glattrohrwärmetauscher oben</b> Top heating coil   Échangeurs de chaleur haut   Serpentino superiore	m <sup>2</sup>	0.5	0.9	0.8	1.3	1.9	1.8	2.2	2.5	2.5	2.9	2.9
<b>Inhalt Glattrohrwärmetauscher</b> Heating coil capacity   Contenance échangeurs de chaleur   Contenuto serpentino	l	2.9	5.7	4.5	8.5	12.3	15.0	18.6	20.9	20.9	24.3	24.3
<b>Durchflussmenge</b> Throughput   Débit   Portata flusso	m <sup>3</sup> / h	0.7	1.2	1.0	1.7	2.4	2.3	2.8	3.2	3.2	3.7	3.7
<b>Druckverlust</b> Pressure loss   Perte de charge   Perdita di pressione	mbar	20	20	10	40	90	30	40	40	40	60	60
<b>Dauerleistung</b> Continuous output   Régime permanent   Potenza continua 10°C / 45°C / 80°C	l / h	181	326	290	471	687	651	796	905	905	1049	1049
<b>max. Glattrohrwärmetauscherleistung</b> max. heating coil output   Puissance max. du échangeurs de chaleur   Potenza max. serpentino	kW	7.4	13.3	11.8	19.2	28.0	26.5	32.4	36.8	36.8	42.7	42.7

**Wassererwärmer für Wärmepumpenanlagen**  
**Domestic hot water tank**  
**Ballon eau chaude sanitaire**  
**Serbatoio di accumulo acqua calda sanitaria**  
**DSFF/E 200-2000**



**Emailliert**  
 Enamelled | Émaillés | Smaltato

200 - 600

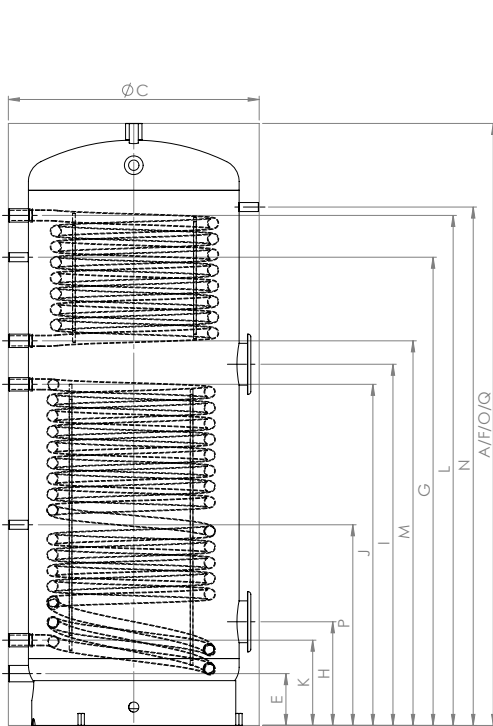

200 - 500

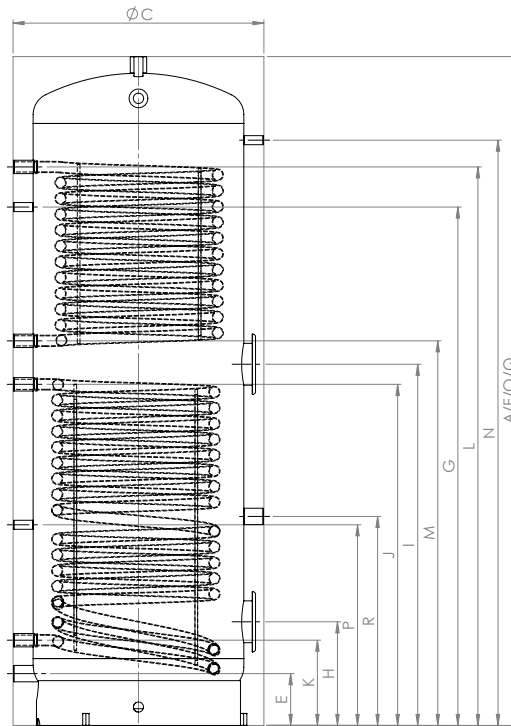

600

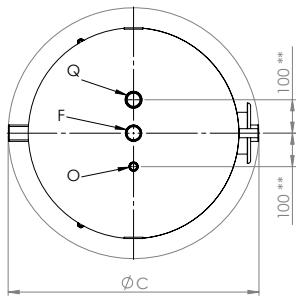

200 - 600

	Verwendung Usage Utilisation Uso	Dimension Dimension Dimension Dimensione	200	300	400	500	600
A	Höhe Height   Hauteur   Altezza	⊙ – mm	1215	1570	1500	1800	2000
C	∅	⊙ – mm	600	650	750	750	750
E	Kaltwasser Cold water   Eau froide   Acqua fredda	↕ – mm	130	140	155	155	155
		G" – mm	1 ¼"	1 ¼"	1 ¼"	1 ¼"	1 ¼"
F	Warmwasser Hot water   Eau chaude   Acqua calda	↕ – mm	1215	1570	1500	1800	2000
		G" – mm	1 ¼"	1 ¼"	1 ¼"	1 ¼"	1 ¼"
G	Zirkulation Circulation   Circulation   Circolazione	↕ – mm	-	1200	1150	1400	1550
		G" – mm	-	½"	½"	½"	½"
H	Flansch unten Flange below   Bride du bas   Flangia inferiore	↕ – mm	285	295	310	310	310
		∅ – mm	180/120	180/120	180/120	180/120	180/120
I	Flansch oben Flange above   Bride du haut   Flangia superiore	↕ – mm	710	920	930	1080	1080
		∅ – mm	1 ½"	180/120	180/120	180/120	180/120
J	VL Glattrohrwärmetauscher unten Bottom heating coil   Échangeurs de chaleur bas   Serpentino inferiore	↕ – mm	640	840	855	1020	1020
		G" – mm	1"	1"	1"	1"	1"
K	RL Glattrohrwärmetauscher unten Bottom heating coil   Échangeurs de chaleur bas   Serpentino inferiore	↕ – mm	240	240	255	255	255
		G" – mm	1"	1"	1"	1"	1"
L	VL Glattrohrwärmetauscher oben Top heating coil   Échangeurs de chaleur haut   Serpentino superiore	↕ – mm	950	1330	1235	1525	1670
		G" – mm	1"	1"	1"	1"	1"
M	RL Glattrohrwärmetauscher oben Top heating coil   Échangeurs de chaleur haut   Serpentino superiore	↕ – mm	780	1000	1000	1150	1150
		G" – mm	1"	1"	1"	1"	1"
N	Thermometer Thermometer   Thermomètre   Termometro	↕ – mm	990	1350	1250	1550	1750
		G" – mm	½"	½"	½"	½"	½"
O	Fühlerhülse Sensor sleeve   Manchon de sonde   Manicotto sensore	↕ – mm	1215	1570	1500	1800	2000
		G" – mm	½"	½"	½"	½"	½"
P	Fühler Sensor   Sonde   Sensor	↕ – mm	-	570	590	600	600
		G" – mm	-	½"	½"	½"	½"
Q	Magnesiumanode Magnesium anode   Anode de magnésium   Anodo in magnesio	↕ – mm	1215	1570	1500	1800	2000
		G" – mm	1 ¼"	1 ¼"	1 ¼"	1 ¼"	1 ¼"
R	Magnesiumanode Magnesium anode   Anode de magnésium   Anodo in magnesio	↕ – mm	-	-	-	-	625
		G" – mm	-	-	-	-	1 ¼"

**Wassererwärmer für Wärmepumpenanlagen**  
**Domestic hot water tank**  
**Ballon eau chaude sanitaire**  
**Serbatoio di accumulo acqua calda sanitaria**  
**DSFF/E 200-2000**



**Emailliert**  
 Enamelled | Émaillés | Smaltato



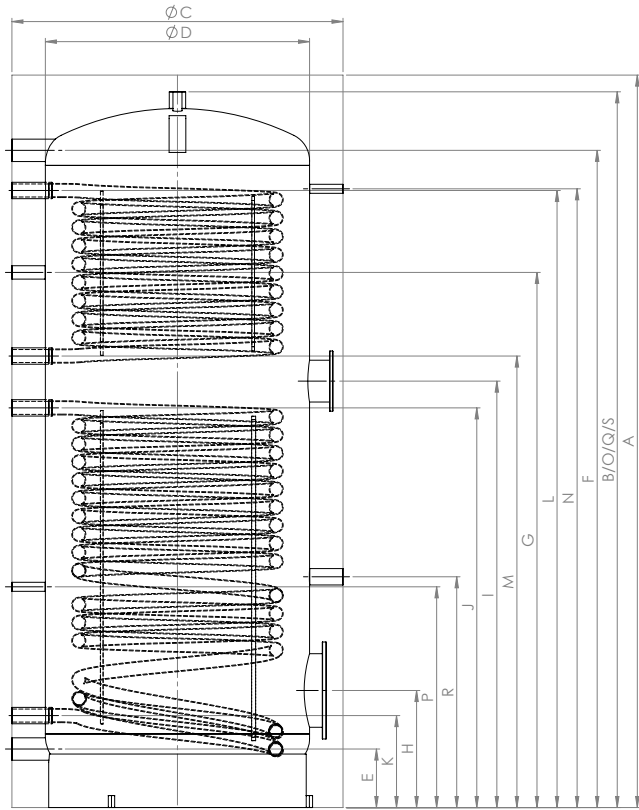



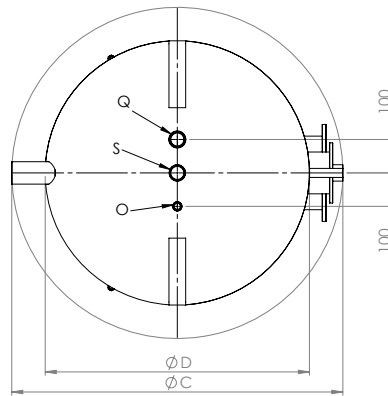











800 - 2000



800 - 2000



800 - 2000

	Verwendung Usage Utilisation Uso	Dimension Dimension Dimension Dimensione	800	1000	1250	1500	1750	2000
A	Höhe Height   Hauteur   Altezza	 – mm	1990	2190	2240	2120	2150	2350
B		 – mm	1940	2140	2190	2070	2100	2300
C	Ø	 – mm	990	990	1100	1200	1300	1300
D		 – mm	790	790	900	1000	1100	1100
E	Kaltwasser Cold water   Eau froide   Acqua fredda	 – mm	175	175	200	220	235	235
		G"	2"	2"	2"	2"	2"	2"
F	Warmwasser Hot water   Eau chaude   Acqua calda	 – mm	1765	1965	1990	1730	1730	1930
		G"	2"	2"	2"	2"	2"	2"
G	Zirkulation Circulation   Circulation   Circolazione	 – mm	1400	1600	1600	1450	1400	1650
		G"	1"	1"	1"	1"	1"	1"
H	Flansch unten Flange below   Bride du bas   Flangia inferiore	 – mm	350	350	400	470	480	480
		Ø – mm	290/220	290/220	290/220	290/220	290/220	290/220
I	Flansch oben Flange above   Bride du haut   Flangia superiore	 – mm	1120	1275	1300	1090	1140	1240
		Ø – mm	180/120	180/120	180/120	180/120	180/120	180/120
J	VL Glattröhrwärmetauscher unten Bottom heating coil   Échangeurs de chaleur bas   Serpentino inferiore	 – mm	1045	1195	1220	1020	1070	1130
		G"	1 ¼"	1 ¼"	1 ¼"	1 ¼"	1 ¼"	1 ¼"
K	RL Glattröhrwärmetauscher unten Bottom heating coil   Échangeurs de chaleur bas   Serpentino inferiore	 – mm	275	275	320	360	360	360
		G"	1 ¼"	1 ¼"	1 ¼"	1 ¼"	1 ¼"	1 ¼"
L	VL Glattröhrwärmetauscher oben Top heating coil   Échangeurs de chaleur haut   Serpentino superiore	 – mm	1580	1845	1880	1600	1620	1790
		G"	1 ¼"	1 ¼"	1 ¼"	1 ¼"	1 ¼"	1 ¼"
M	RL Glattröhrwärmetauscher oben Top heating coil   Échangeurs de chaleur haut   Serpentino superiore	 – mm	1195	1350	1380	1160	1200	1350
		G"	1 ¼"	1 ¼"	1 ¼"	1 ¼"	1 ¼"	1 ¼"
N	Thermometer Thermometer   Thermomètre   Termometro	 – mm	1650	1850	1900	1750	1750	1950
		G"	½"	½"	½"	½"	½"	½"
O	Fühlerhülse Sensor sleeve   Manchon de sonde   Manicotto sensore	 – mm	1940	2140	2190	2070	2100	2300
		G"	½"	½"	½"	½"	½"	½"
P	Fühler Sensor   Sonde   Sensor	 – mm	660	660	680	590	600	600
		G"	½"	½"	½"	½"	½"	½"
Q	Magnesiumanode Magnesium anode   Anode de magnésium   Anodo in magnesio	 – mm	1940	2140	2190	2070	2100	2300
		G"	1 ¼"	1 ¼"	1 ¼"	1 ¼"	1 ¼"	1 ¼"
R	Magnesiumanode Magnesium anode   Anode de magnésium   Anodo in magnesio	 – mm	690	690	710	800	810	820
		G"	1 ¼"	1 ¼"	1 ¼"	1 ¼"	1 ¼"	1 ¼"
S	Anschluss oben Connection top   Lien ci-dessus   Collegamento sopra	 – mm	1940	2140	2190	2070	2100	2300
		G"	1 ¼"	1 ¼"	1 ¼"	1 ¼"	1 ¼"	1 ¼"



**Wassererwärmer für Wärmepumpenanlagen**  
**Domestic hot water tank**  
**Ballon eau chaude sanitaire**  
**Serbatoio di accumulo acqua calda sanitaria**  
**DSFFL/E 300 – 500**

**DIN**

**EN 12897**  
**EnEV 730.02**  
**ErP 812/2013**  
**ErP 814/2013**  
**DIN 4753**

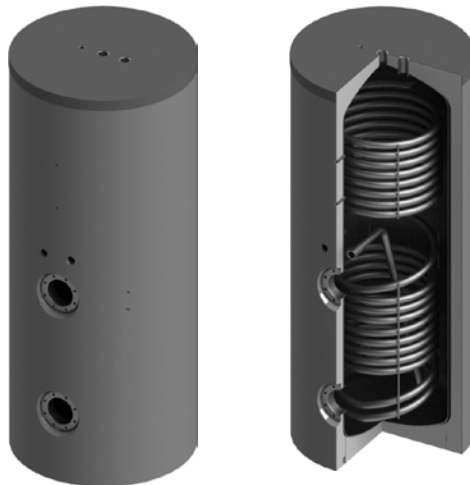

**Bauart**  
 Design | Structure | Struttura

Die Speicher werden aus hochwertigem Stahl nach EN 10025 gefertigt.  
 Die Speicher werden nach EN 12897:2014 dimensioniert, gefertigt und zertifiziert.

**EN** The storage tanks are made from high quality steel in accordance with EN 10025.  
 The storage tanks are designed, manufactured and certified in accordance with EN 12897:2014.

**FR** Les ballons sont fabriqués en acier de grande qualité selon la norme EN 10025.  
 Les ballons sont dimensionnés, fabriqués et certifiés selon la norme EN 12897:2014.

**IT** Gli accumulatori sono realizzati in acciaio pregiato secondo la norma EN 10025.  
 Gli accumulatori sono dimensionati, costruiti e certificati secondo la norma EN 12897:2014.

**Lieferumfang**  
 Delivery | Livraison | Consegna

	l	mm		Art. Nr.
<b>Bedienungsanleitung</b> Operation manual   Mode d'emploi   Istruzioni per l'uso			1 x	
<b>Thermometer mit Tauchhülse</b> Thermometer with immersion sleeve   Thermomètre avec manchon d'immersion   Termometro con manicotto ad immersione		100	1 x	6001150100
<b>Tauchhülse</b> Immersion sleeve   Manchon d'immersion   Manicotto ad immersione		1000	1 x	6001181011
<b>Magnesium Schutzanode</b> Magnesium protective anode   Anode protectrice de magnésium   Anodo protettivo in magnesio	300	750	1 x	6001140750
	500	1000	1 x	6001141000

### Schutz vor Korrosion

#### Anti-corrosion protection | Protection contre la corrosion | Protezione anticorrosiva

Doppelt gebrannte Zweischicht-Emallierung nach DIN 4753. Grosszügige Magnesium Schutzanode nach DIN 4753-3. Speicher mit separater Isolierung sind aussen mit einem Antikorrosionslack lackiert.

**EN** Dual-fired two-layer enamelling in accordance with DIN 4753. Generous magnesium protection anode in accordance with DIN 4753-3. Storage tanks with separate insulation are coated on the exterior with an anticorrosion paint.

**FR** Émaillage bi-couche à double cuisson conforme à la norme DIN 4753. Anode de protection de belle taille en magnésium conforme à la norme DIN 4753-3. Les réservoirs avec isolation séparée sont recouverts à l'extérieur d'une laque anticorrosion.

**IT** Smaltatura a doppia mano secondo DIN 4753. Anodo protettivo di magnesio in grande quantità secondo DIN 4753-3. Gli accumulatori con isolamento separato sono verniciati esternamente con smalto resistente alla corrosione.

### Wärmetauscher

#### Heat exchanger | Échangeur de chaleur | Scambiatore di calore

Zwei eingeschweisste grossflächige Wärmetauscher.

**EN** Two welded large-surface heat exchangers.

**FR** Deux échangeurs de chaleur grande surface soudés.

**IT** Due scambiatori di calore di grande superficie saldati.

### Isolierung

#### Insulation | Isolation | Isolamento

##### PU-Hartschaum

60 mm PU-Hartschaum fix geschäumt. Skaimantel 5 mm mit Reissverschluss vormontiert, inklusive Rosetten und Abdeckhaube. Brandschutzklasse B2. Silber. Weitere Farben nach Absprache.

##### EN Rigid polyurethane foam

60 mm rigid polyurethane foam. Skai jacket 5 mm with zip preassembled, including cover plates and hood. Fire-resistance rating B2. Silver. Other colours on request.

##### FR Mousse solidifiée PU

60 mm de mousse dure PU Enveloppe en skai de 5 mm préinstallée avec fermeture à glissière, y compris rosettes et capot. Classe allemande de protection incendie B2. Argent. Autres couleurs après concertation.

##### IT Schiuma PU rigida

60 mm di schiuma rigida di poliuretano fissa. Mantello in skai da 5 mm pre-assemblato con cerniera, dotato di rosette e calotta di copertura. Classe di resistenza antincendio B2. Argento. Altri colori su richiesta.

≤ 600 L  
PU-Hartschaum  
B2;  $\lambda = 0.026 \text{ W/(mK)}$

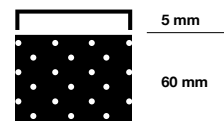

**Wassererwärmer für Wärmepumpenanlagen**  
**Domestic hot water tank**  
**Ballon eau chaude sanitaire**  
**Serbatoio di accumulo acqua calda sanitaria**  
**DSFFL/E 300–500**



**Emailliert**  
 Enamelled | Émaillés | Smaltato

Typ DSFFL/E		300	500
Inhalt Capacity   Contenance   Contenuto	l	304	498
Ø mit Isolierung with insulation   avec isolation   con isolamento	mm	650	750
Ø ohne Isolierung without insulation   sans isolation   senza isolamento	mm	-	-
Höhe mit Isolierung Height with insulation   Hauteur avec isolation   Altezza con isolamento	mm	1570	1800
Kippmass Tilted dimension   Cote de basculement   Altezza in raddrizzamento	mm	1700	1950
Betriebsdruck Heizung Heater operating pressure   Pression de service du chauffage   Pressione d'esercizio riscaldamento	bar	6	6
Betriebsdruck Wasser Water operating pressure   Pression de service de l'eau   Pressione d'esercizio acqua	bar	6	6
Prüfdruck Test pressure   Pression test   Pressione di collaudo	bar	12	12
max. Betriebstemperatur max. operating temperature   Temp. de service max.   Temperatura max. d'esercizio	°C	95	95
Gewicht Weight   Poids   Peso	kg	134	185
Art.Nr. 100110... Part no.   Réf.   Art.n.		0300	0500
<b>Isolierung</b> Insulation   Isolation   Isolamento		<b>60 mm</b> fix eingeschäumt Fixed with foam   Enrobage mousse fixe   Schiuma rigida fissa	
Wärmeverlust Heat losses   Pertes thermiques   Perdita di calore	kWh/24h	1.40	1.89
ErP-Klasse ErP class   Classe ErP   Classe ErP		B	B

Typ DSFFL/E		300	500
<b>Glattrohrwärmetauscher unten</b> Bottom heating coil   Échangeurs de chaleur bas   Serpentino inferiore	m <sup>2</sup>	1.3	1.8
<b>Inhalt Glattrohrwärmetauscher</b> Heating coil capacity   Contenance échangeurs de chaleur   Contenuto serpentino	l	8.2	11.6
<b>Durchflussmenge</b> Throughput   Débit   Portata flusso	m <sup>3</sup> / h	3.0	3.0
<b>Druckverlust</b> Pressure loss   Perte de charge   Perdita di pressione	mbar	180	250
<b>Dauerleistung</b> Continuous output   Régime permanent   Potenza continua 10°C / 45°C / 80°C	l / h	595	794
<b>max. Glattrohrwärmetauscherleistung</b> max. heating coil output   Puissance max. du échangeurs de chaleur   Potenza max. serpentino	kW	24.6	33.2
Typ DSFFL/E		300	500
<b>Glattrohrwärmetauscher oben</b> Top heating coil   Échangeurs de chaleur haut   Serpentino superiore	m <sup>2</sup>	0.9	1.3
<b>Inhalt Glattrohrwärmetauscher</b> Heating coil capacity   Contenance échangeurs de chaleur   Contenuto serpentino	l	5.7	8.5
<b>Durchflussmenge</b> Throughput   Débit   Portata flusso	m <sup>3</sup> / h	1.2	1.7
<b>Druckverlust</b> Pressure loss   Perte de charge   Perdita di pressione	mbar	20	40
<b>Dauerleistung</b> Continuous output   Régime permanent   Potenza continua 10°C / 45°C / 80°C	l / h	326	471
<b>max. Glattrohrwärmetauscherleistung</b> max. heating coil output   Puissance max. du échangeurs de chaleur   Potenza max. serpentino	kW	13.3	19.2



